

looks **Similar.**
But completely
Different.



ASBF25-H/30-H Hand Pallet Truck

Load capacity: 2500kg/3000kg



Effortless



Durable



Cost Effective



Outstanding Quality

ARAS Developments FZE

T: +971 4 887 6602

W: www.arasfze.com

ARAS
Handling Equipment

Easy to Pull, Built to Last

45% less pulling force

■ Effortless steering

High-quality, wear-resistant nylon and polyurethane wheels, with high load capacity, and smooth, effortless steering.

■ Less starting force to move a load

High-precision chassis with less starting force, easily handling loads of 2500 and 3000kg.

■ Smooth lifting and lowering

Rubber-coated handle, comfortable, non-slip grip and wear-resistant
 Three lever control for easy operation
 Standard with handle lever release and foot pedal release
 Adjustable lowering speed
 Handle lever automatically returns to neutral position after release.

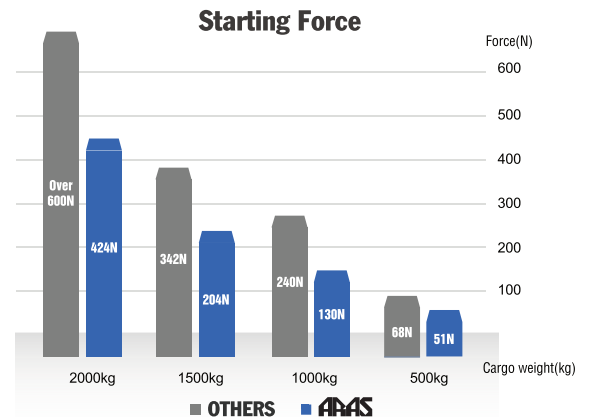
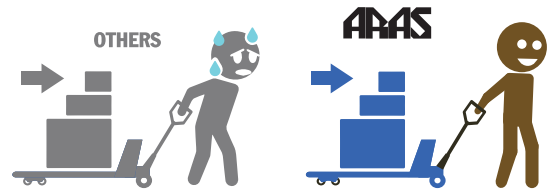

Quality and Durability



■ High-strength chassis with 100% automated robotic welding

Minimal welding deformation, high precision and consistency, guaranteed welding quality.

■ Reinforced top cap

Additional support structures to increase strength and extend lifespan.

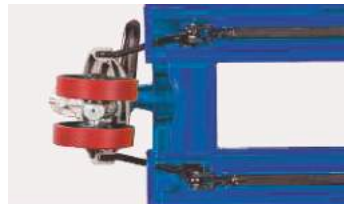

■ Adjustable push rod

If two forks are not balanced after one year use, push rod can be adjusted to make the forks back to same height.

■ Grooved V-block for extra reinforcement

■ High-quality, wear-resistant steer wheels and load wheels

■ Reinforced forks

Additional stiffeners on back of the forks for increased load capacity.
 Grooved forks, with a 400kg increase in static load capacity compared to flat forks.

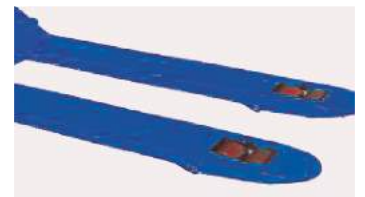

■ Enhanced Rocker Arm



■ Big opening space for load wheels

A big opening space for load wheels, offering enhanced protection for the wheels, push rod, and wheel forks.

Cost Effective

- **One-piece cast pump with guaranteed quality, durable and easy to service**

Over 200,000 times mechanical tests on working life.
Thickened steel spring for stronger elasticity and longer working life.

- **High-quality, high-standard electrostatic powder coating**

High level appearance with thick coating, strong adhesion, high corrosion resistance and wear resistance.



Wheel Options

Multiple options for wheels to suit different working conditions.



Strict Quality Control

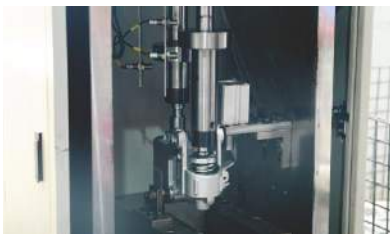

- **100% pump inspection**



- **Robotic welding**



- **Automatic powder coating**



- **Assembly line**



- **Pre-delivery inspection**



- **Solid packaging**

Specifications

MODEL		ASBF25-H			ASBF30-H			
FEATURE								
1.1	capacity	kg	2500			3000		
1.2	pump type		ASBF			ASBF		
WHEEL								
2.1	wheel (drive/load) type		PU/RU/Nylon			PU/RU/Nylon		
2.2	size of steering wheel	ΦD mm	180*50	180*50	200*50	180*50	180*50	200*50
2.3	size of loading wheel(single wheel)	Φd mm	74*93	80*93	80*93	74*93	80*93	80*93
2.4	size of loading wheel(double wheel)	Φd mm	74*70	80*70	80*70	74*70	80*70	80*70
DIMENSIONS								
3.1	lifting height	h mm	115			115		
3.2	max. fork height	H mm	195	200	200	195	200	200
3.3	min. fork height	H1 mm	75	85	85	75	85	85
3.4	fork outer width	W mm	520/550/685			520/550/685		
3.5	fork length	L mm	900/1100/1150/1220			900/1100/1150/1220		
3.6	fork width	S mm	160			160		
3.7	steel thickness (after painting)	mm	3			3.75		
3.8	weight	kg	61.5~68.5			71~78.5		

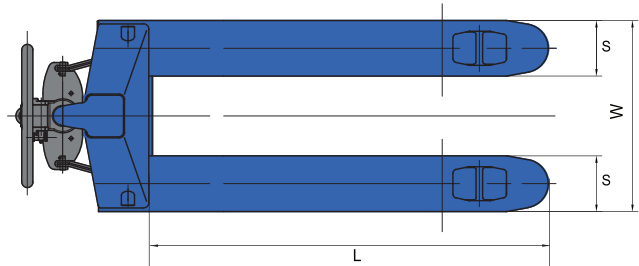
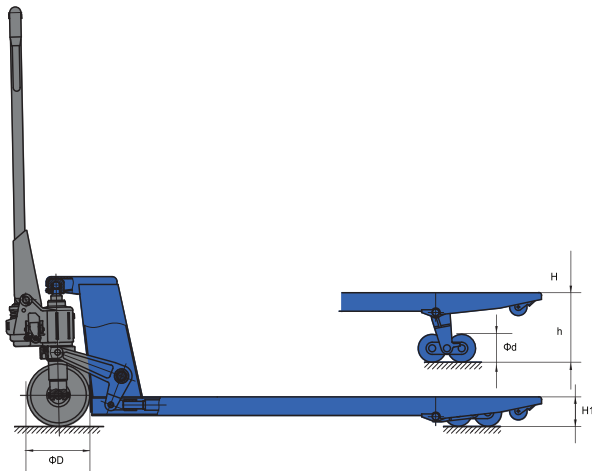

MAKE YOUR JOB EASIER